

300

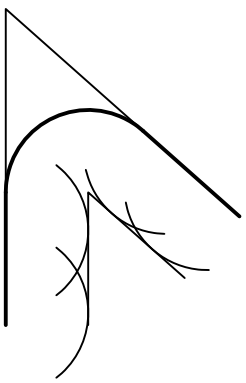
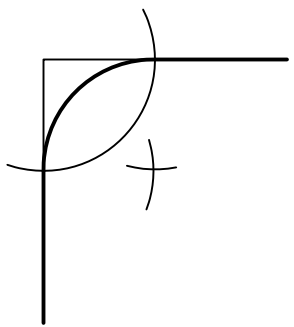
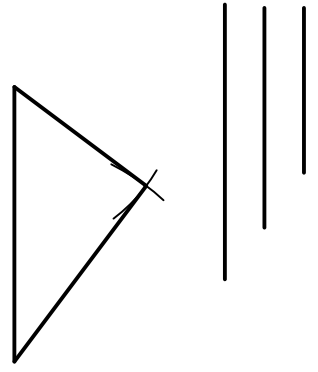
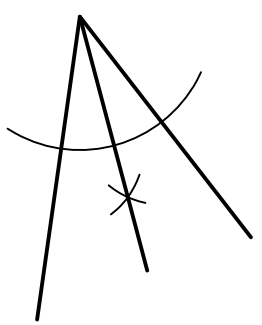
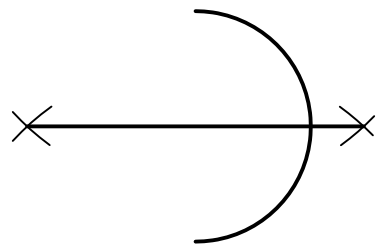
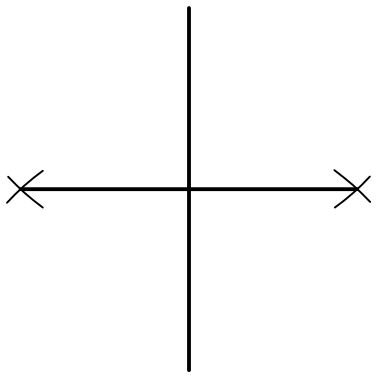

75

150

DRAWN BY		TITLE		
I.D.	SEC.	GEOMETRIC		
CHECKED BY	SCALE			
				5

300

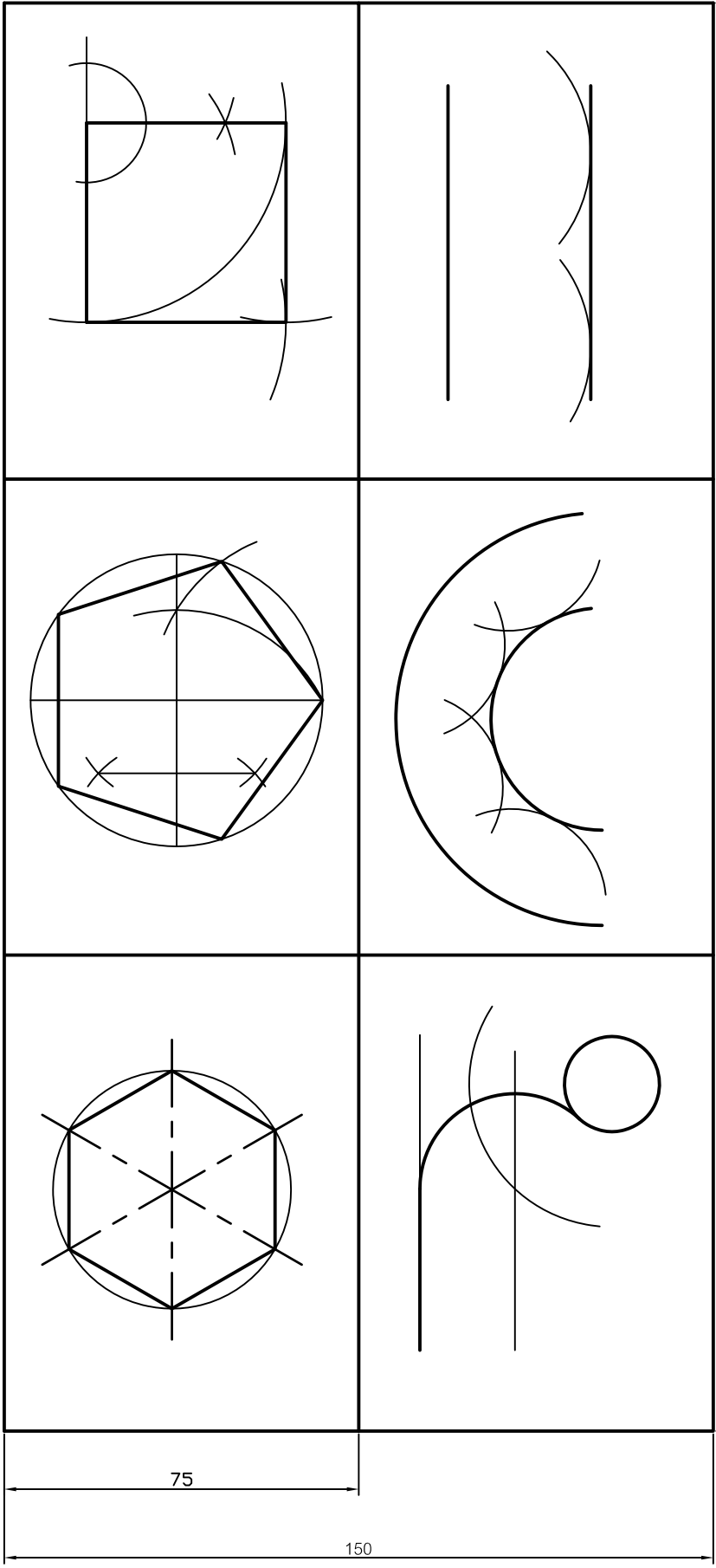

DRAWN BY		TITLE	
I.D.	SEC.	GEOMETRIC2	
CHECKED BY	SCALE		
	DATE	NO.	6

300

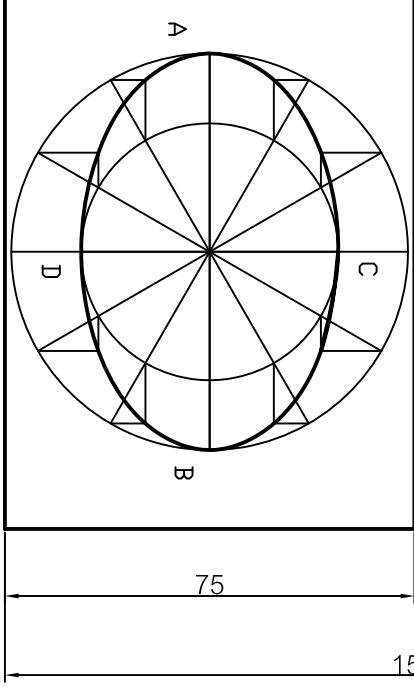
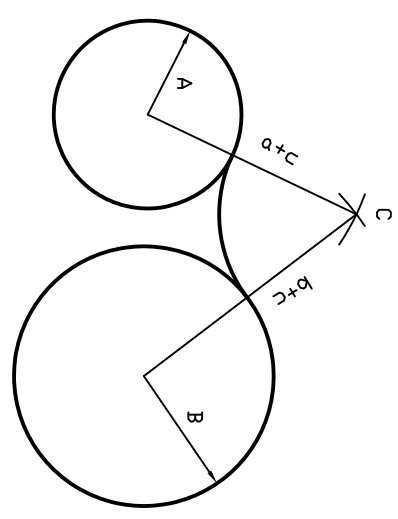
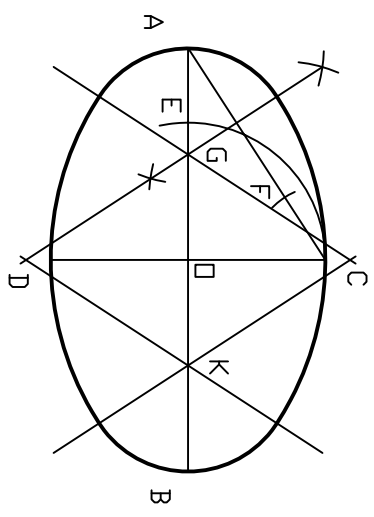
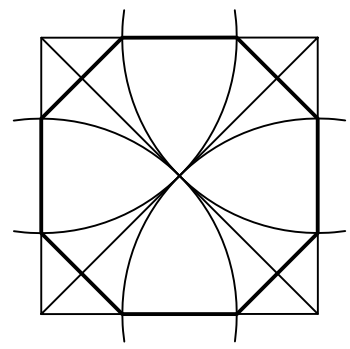
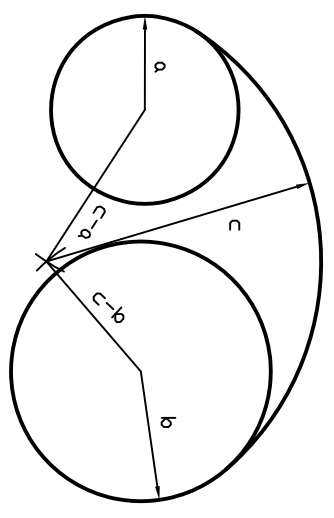
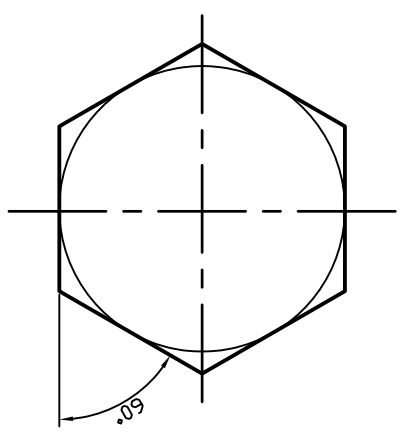

DRAWN BY		TITLE	
I.D.	SEC.	GEOMETRICS3	
CHECKED BY			
			ND.
			7

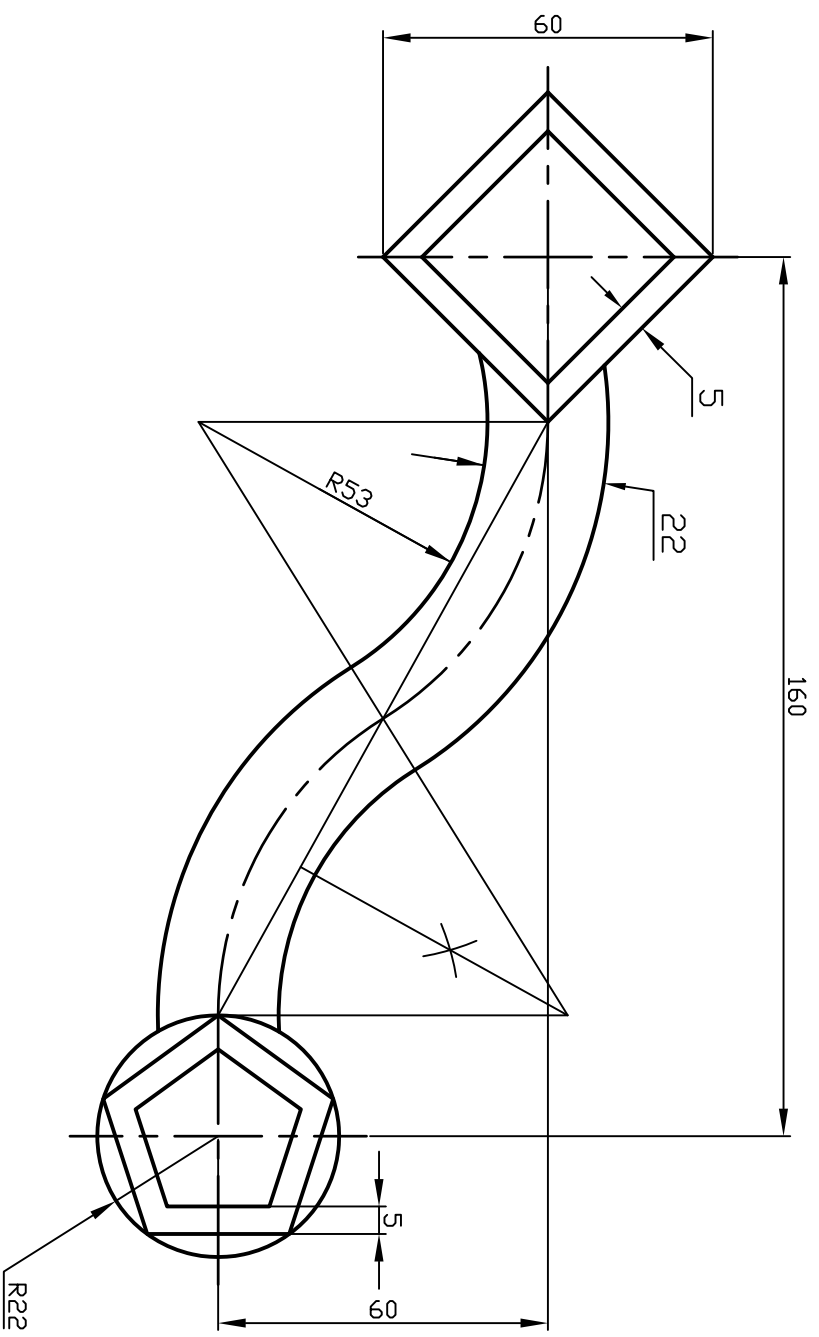

DRAWN BY		TITLE	
I.D.	SEC.	GEOMETRIC 4	
CHECKED BY			
SCALE		DATE	NO.
			8