

DRAWN BY		TITLE		
I.D.	SEC.	ISOMETRIC		
CHECKED BY	SCALE			
				10

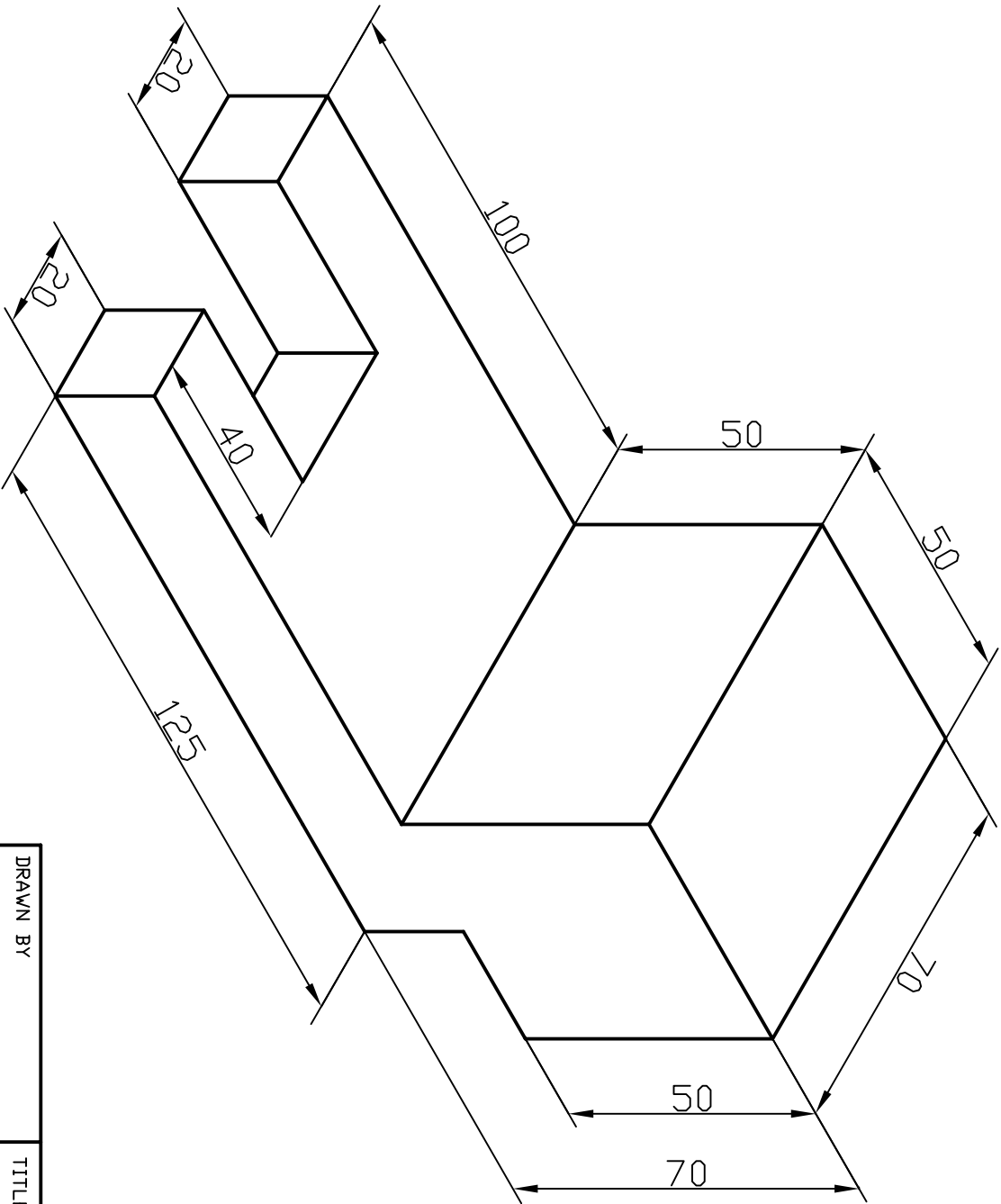

DRAWN BY		TITLE	
I.D.	SEC.	ISOMETRIC2	
CHECKED BY			
SCALE		DATE	NO.
			11

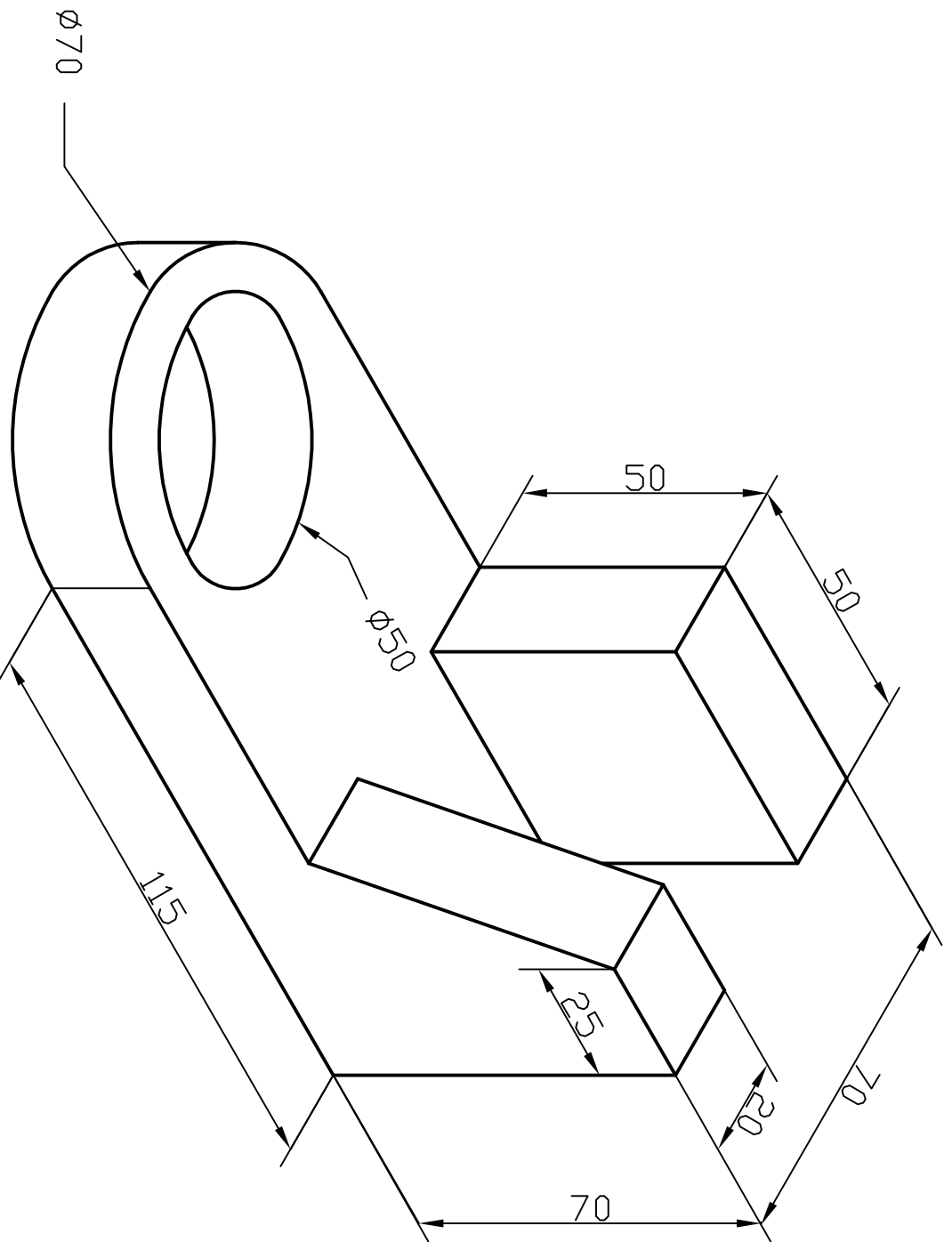

DRAWN BY		TITLE	
I.D.	SEC.	ISOMETRIC3	
CHECKED BY			
SCALE	DATE	ND.	
1:1		12	

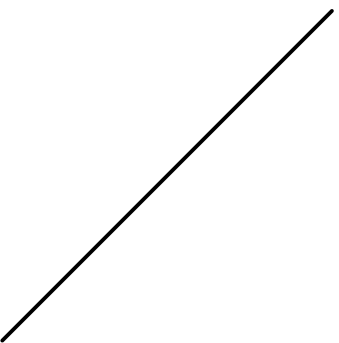
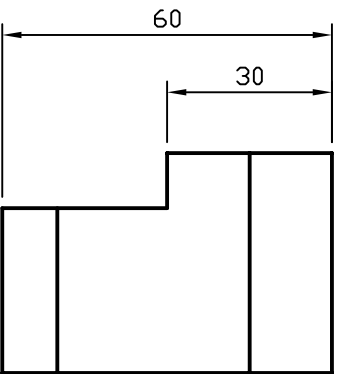
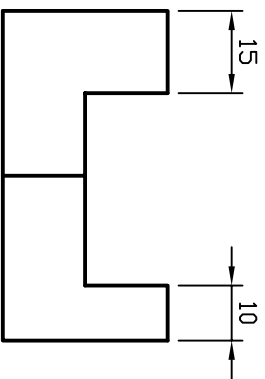
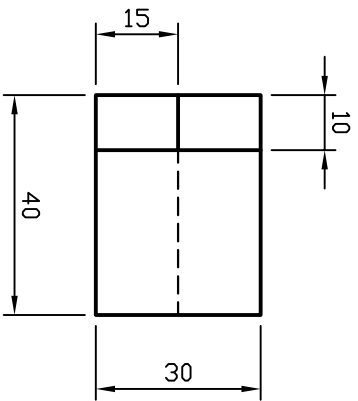
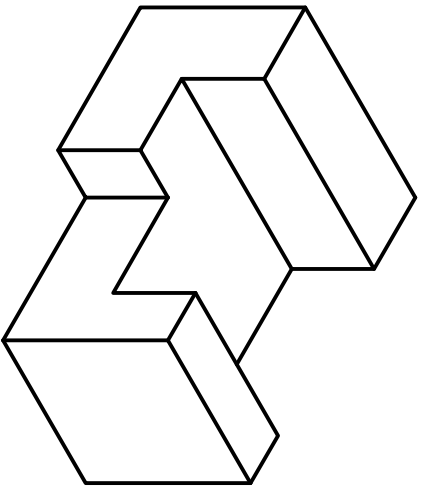

DRAWN BY		TITLE	
I.D.	SEC.	PROJECTION1	
CHECKED BY	SCALE	DATE	NO.
	1:1		13

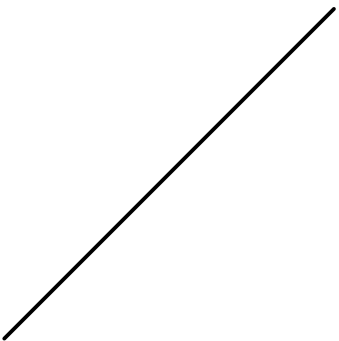
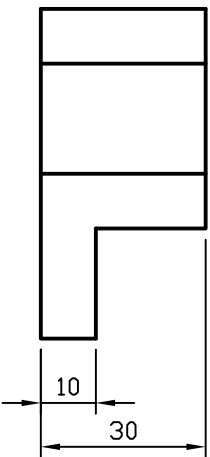
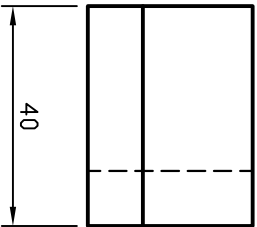
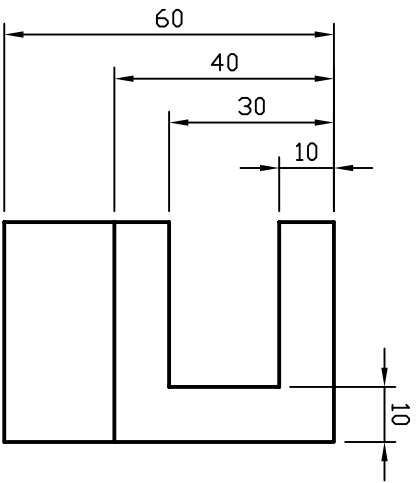
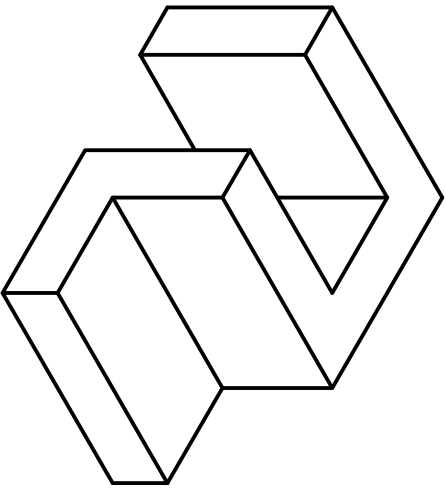

DRAWN BY		TITLE		
I.D.	SEC.	PROJECTION2		
CHECKED BY	SCALE	DATE	ND.	
	1:1		14	

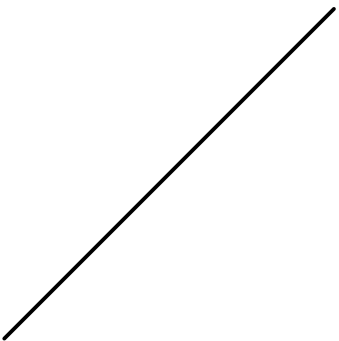
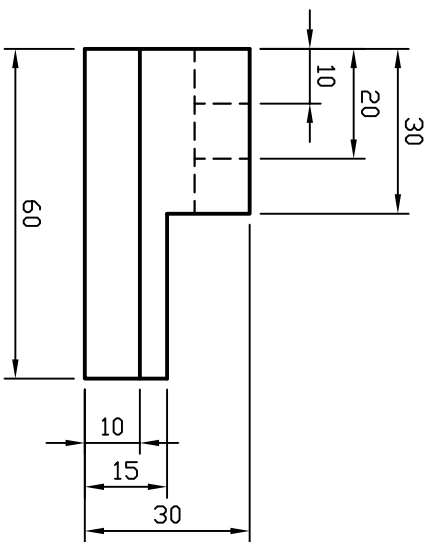
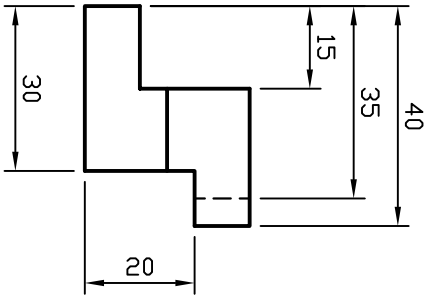
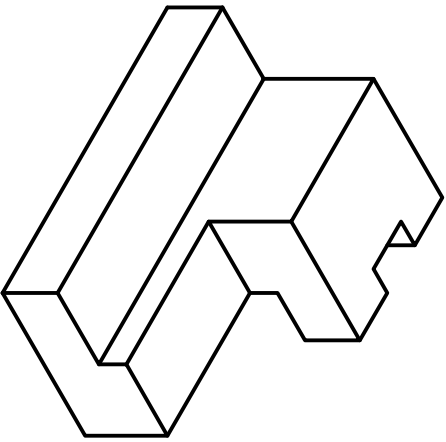

DRAWN BY		TITLE		
I.D.	SEC.	PROJECTIONS3		
CHECKED BY	SCALE	DATE	ND.	
	1:1		15	

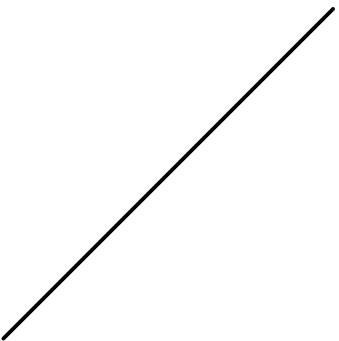
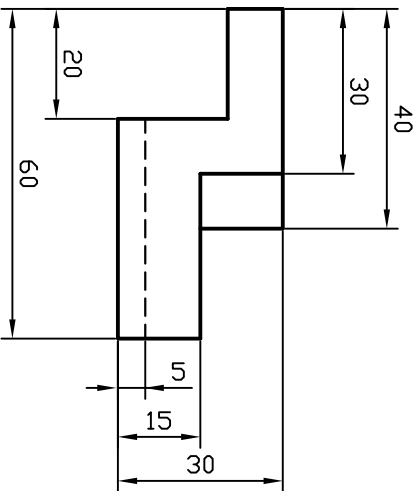
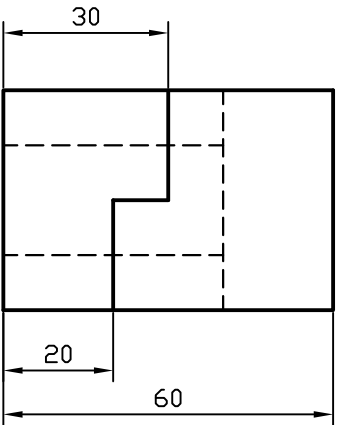
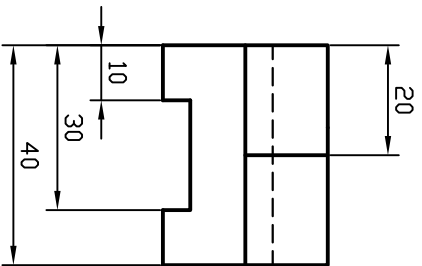

DRAWN BY		TITLE	
I.D.	SEC.	PROJECTION 4	
CHECKED BY	SCALE	DATE	NO.
	1:1		16

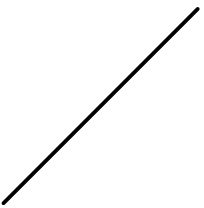
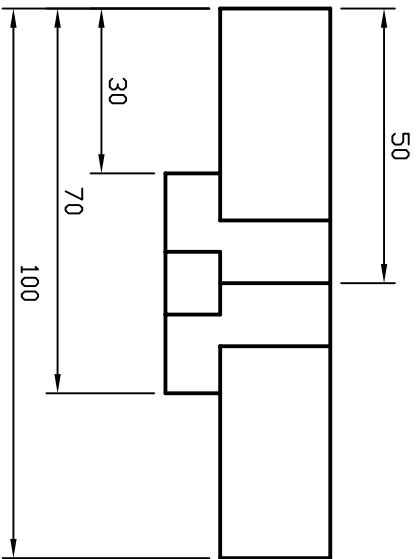
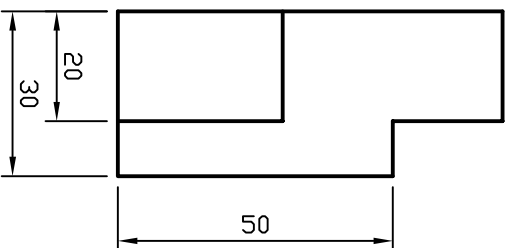
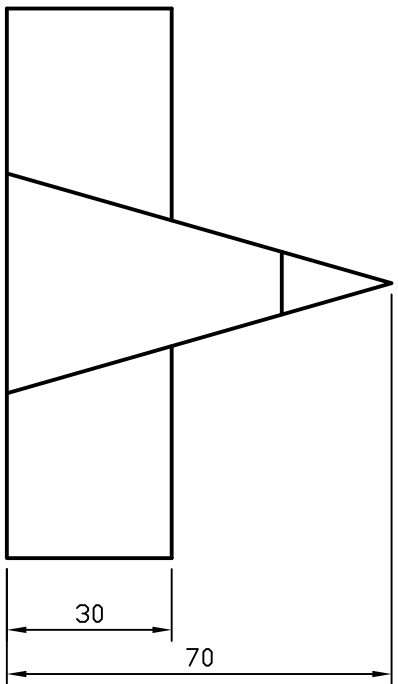
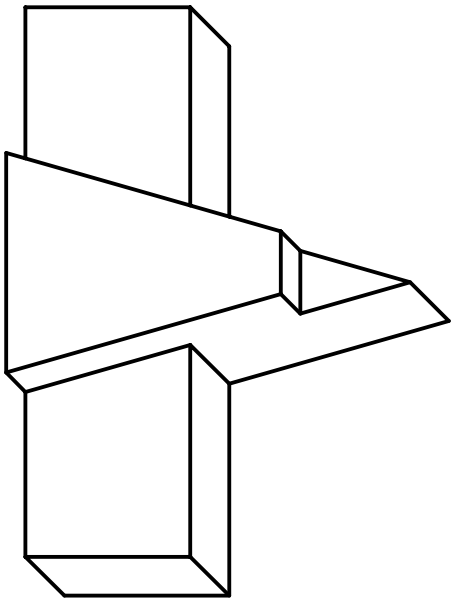

DRAWN BY		TITLE	
I.D.	SEC.	OBLIQUE 1	
CHECKED BY			
SCALE		DATE	ND.
1:1			17

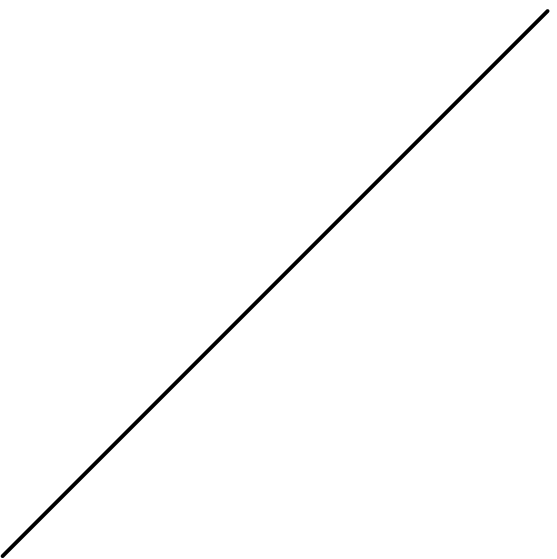
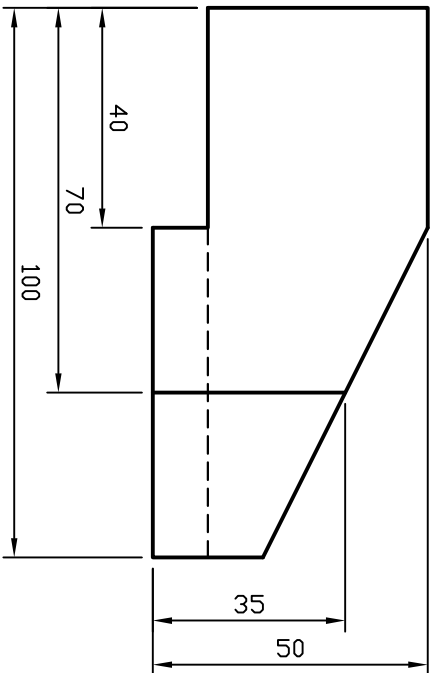
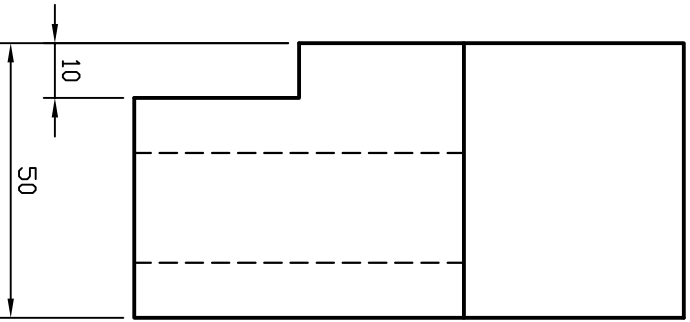
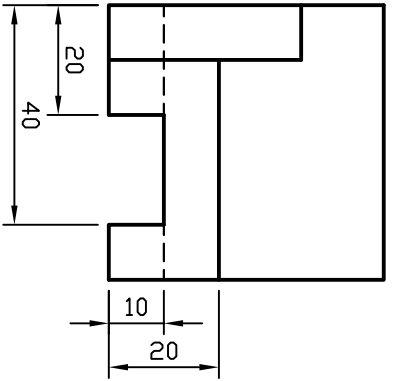

DRAWN BY		TITLE		
I.D.	SEC.	OBLIQUE2		
CHECKED BY	SCALE	DATE	ND.	
	1:1		18	